

BRINKMANN®

Tailgate Gas Grill Tailgate Parrilla a Gas

OWNER'S MANUAL / MANUAL DEL PROPIETARIO

**ASSEMBLY AND OPERATING INSTRUCTIONS
INSTRUCCIONES DE ARMADO Y OPERACIÓN**

**SAVE THIS MANUAL FOR FUTURE REFERENCE
GUARDE ESTE MANUAL PARA REFERENCIA FUTURA**

NOTICE TO INSTALLER:

LEAVE THESE INSTRUCTIONS
WITH THE GRILL OWNER FOR
FUTURE REFERENCE.

AVISO PARA EL INSTALADOR:

ENTREGUE ESTAS
INSTRUCCIONES AL
PROPIETARIO DE LA PARRILLA
PARA REFERENCIA FUTURA.

⚠ WARNING/ADVERTENCIA

HAZARDOUS EXPLOSION MAY RESULT IF THESE WARNINGS AND INSTRUCTIONS ARE IGNORED. READ AND FOLLOW ALL WARNINGS AND INSTRUCTIONS IN THIS MANUAL TO AVOID PERSONAL INJURY, INCLUDING DEATH OR PROPERTY DAMAGE.

SE PUEDE PRODUCIR UNA EXPLOSIÓN PELIGROSA SI SE HACE CASO OMISO A ESTAS ADVERTENCIAS E INSTRUCCIONES. LEA Y SIGA TODAS LAS ADVERTENCIAS E INSTRUCCIONES EN ESTE MANUAL PARA EVITAR LESIONES PERSONALES, INCLUSO LA MUERTE, O LOS DAÑOS MATERIALES.



IMPORTANT SAFETY WARNINGS

WE WANT YOU TO ASSEMBLE AND USE YOUR GRILL AS SAFELY AS POSSIBLE. THE PURPOSE OF THIS SAFETY ALERT SYMBOL  IS TO ATTRACT YOUR ATTENTION TO POSSIBLE HAZARDS AS YOU ASSEMBLE AND USE YOUR GRILL.

WHEN YOU SEE THE SAFETY ALERT SYMBOL  PAY CLOSE ATTENTION TO THE INFORMATION WHICH FOLLOWS!

 READ ALL SAFETY WARNINGS AND INSTRUCTIONS CAREFULLY BEFORE ASSEMBLING AND OPERATING YOUR GRILL.

DANGER

IF YOU SMELL GAS:

1. Shut off gas to the appliance.
2. Extinguish any open flame.
3. Open Lid.
4. If odor continues, keep away from the appliance and immediately call your gas supplier or your fire department.

WARNING

1. DO NOT store or use gasoline or other flammable liquids or vapors in the vicinity of this or any other appliance.
2. An LP cylinder not connected for use shall not be stored in the vicinity of this or any other appliance.

DANGER



- a) DO NOT store a spare LP cylinder under or near this appliance.
- b) Never fill the cylinder beyond 80% full.
- c) If the information in (a) and (b) are not followed exactly, a fire causing death or serious injury may occur.

TABLE OF CONTENTS

General Warnings	3
Installation and LP Cylinder Specifications and Safe Use.	4–6
Connecting LP Cylinder and Hose / Regulator to Grill	6–7
Leak Testing.	8–9
Pre-start Check List	9
Lighting Instructions	10–11
Operating Grill and Helpful Hints.	12–13
Proper Care and Maintenance	13–15
Transporting and Storage	15
Trouble Shooting	16
Frequently Asked Questions	17–18
Parts List and Assembly Instructions.	19–28
Breakdown Instructions for Transporting.	29–33
Warranty Information.	Back Cover

⚠ DANGER: Indicates an imminently hazardous situation which, if not avoided, will result in death or serious injury.

⚠ WARNING: Be alert to the possibility of serious bodily injury if the instructions are not followed. Be sure to read and carefully follow all of the messages.

⚠ CAUTION: Indicates a potentially hazardous situation which, if not avoided, may result in minor or moderate injury.

FOR COVERS, ACCESSORIES AND OTHER PRODUCTS, PLEASE VISIT US ONLINE AT:
www.brinkmann.net

GENERAL WARNINGS

⚠ WARNING

- Never use natural gas in a unit designed for liquid propane gas.
- When raising or lowering the grill, make sure area around “pinch points” are clear.
- Never operate this grill while grill legs are in the collapsed position, damage to floor or gas hose may occur.
- Never use charcoal or wood briquets in a gas grill. Flavoring chips must be contained in a metal smoking box to contain ash and prevent fires.
- Leak test all connections before first use, even if grill was purchased fully assembled and after each tank refill.
- Never check for leaks using a match or open flame.

⚠ CAUTION! Strong odors, colds, sinus congestion, etc. may prevent the detection of propane. Use caution and common sense when testing for leaks.

- Always keep your gas grill free and clear of gasoline, lighter fluid, paint thinner, or other flammable vapors and liquids or combustible materials.
- Always check the grill prior to each use as indicated in the "Pre-Start Check List" section of this manual.
- DO NOT obstruct the flow of combustion or ventilation air.
- Never place more than 15 pounds on the side shelf. DO NOT lean on the side shelf.
- Keep children and pets away from hot grill. DO NOT allow children to use or play near this grill.
- DO NOT leave the grill unattended while in use.
- DO NOT allow the gas hose to come in contact with hot surfaces.
- DO NOT allow grease from drain hole to fall on hose or valve regulator assembly.
- After cooking, allow grill and grease cup to cool off completely before removing grease cup. Insert grease cup into grease cup holder before grill transport or storage.
- Use gloves or oven mitts to hold grease cup when removing from grill to avoid spilling hot grease.
- Keep any electrical supply cords away from water or heated surfaces.
- Keep a fire extinguisher on hand acceptable for use with gas products. Refer to your local authority to determine proper size and type.
- For household use only. DO NOT use this grill for anything other than its intended purpose.
- DO NOT use while under the influence of drugs or alcohol.
- Grill is hot when in use. To avoid burns:
 - DO NOT attempt to move the grill.
 - Wear protective gloves or oven mitts.
 - DO NOT touch any hot grill surfaces.
 - DO NOT wear loose clothing or allow hair to come in contact with grill.

⚠ USE CAUTION AND COMMON SENSE WHEN OPERATING YOUR GAS GRILL.

FAILURE TO ADHERE TO THE SAFETY WARNINGS AND GUIDELINES IN THIS MANUAL COULD RESULT IN SEVERE BODILY INJURY OR PROPERTY DAMAGE.

SAVE THIS MANUAL FOR FUTURE REFERENCE.

WARNING

- **FOR OUTDOOR USE ONLY. DO NOT** operate indoors or in an enclosed area such as a garage, shed or breezeway.
- Use your grill **OUTDOORS** in a well ventilated space away from dwellings or other buildings to prevent dangers associated with gas accumulation and toxic vapors. Although minimum clearance is 36 inches (91 cm), we strongly recommend that you do not operate this appliance within 10 ft. (3.0 m) of any structure, combustible material or extra LP gas cylinders not attached to the appliance. Not adhering to these clearances will prevent proper ventilation and may increase the risk of a fire and/or property damage, which could also result in personal injury.
- Maintain a minimum clearance of 36 inches (91 cm) between all sides of grill, deck railings, walls or other combustible material. **DO NOT** use grill under overhead unprotected combustible construction.
- **DO NOT** use or install this grill in or on a recreational vehicle and/or boat.

INSTALLATION INFORMATION:

The installation of this appliance must be in accordance with:

All applicable local codes, or in the absence of local codes, either:

- National Fuel Gas Code ANSI Z223.1 NFPA 54
- Natural Gas and Propane Installation Code: CAN/CGA B149.1
- Natural Gas Installation Code: CAN/CGA B149.1 (Canada)
- Propane Installation Code: CAN/CGA B149.2 (Canada)

To check your local codes, see your local LP gas dealer or natural gas company. This grill was not intended to be connected to a natural gas supply line. If an external electrical source is utilized, it must be electrically grounded in accordance with local codes, or in the absence of local codes, with the National Electrical Code, ANSI/NFPA 70, or the Canadian Electrical Code, CSA 22.1.

WARNING

LP GAS CYLINDER (NOT SUPPLIED WITH THIS GRILL)

The LP cylinder is available for purchase at the same location the grill was purchased.

The LP (Liquid Propane) gas cylinder specifically designed to be used with this grill must have a 20 lb. (9.1 kg) capacity incorporating a Type 1 cylinder valve and an over-filling protection device (OPD).

- This grill is designed to fit Worthington, Manchester or SMPC brand 20 lb. (9.1 kg) cylinders. Other brand DOT cylinders may fit this grill if the cylinder has similar dimensions of the top and bottom rings.
- **DO NOT** connect this grill to an existing #510 POL cylinder valve with Left Hand threads. The Type 1 valve can be identified with the large external threads on the valve outlet.
- **DO NOT** connect to a propane cylinder exceeding this capacity.
- **DO NOT** connect to a cylinder that uses any other type of valve connection device.

CYLINDER SPECIFICATIONS:

When purchasing or exchanging a cylinder for your gas grill, it must be constructed and marked in accordance with the specifications for LP gas cylinders of the U.S. Department of Transportation (DOT) or the National Standard of Canada, CAN/CSA-B339 Cylinders, Spheres and Tubes for Transportation of Dangerous Goods; and Commission, as applicable; and provided with a listed over-filling prevention device (OPD), and provided with a cylinder connection device compatible with the connection for outdoor cooking appliances.

The cylinder must also be equipped with:

- A shut-off valve terminating in a Type 1 gas cylinder valve outlet.
- A Type 1 valve that prevents gas flow until a positive seal is obtained.
- An arrangement for vapor withdrawal.
- A collar to protect the cylinder shut-off valve.
- A safety relief device having direct communication with the vapor space of the cylinder.
- A listed over-filling prevention device (OPD).

WARNING

- Turn off the cylinder valve when your grill is not in use.
- Handle the tank with care.
- Always secure the cylinder in an upright position.
- Never connect an unregulated LP gas cylinder to your grill.
- DO NOT expose LP gas cylinders to excessive heat or ignition sources.
- DO NOT store a spare LP gas cylinder under or near your grill.
- Allow only qualified LP gas dealers to fill or repair your LP gas cylinder.
- DO NOT allow the cylinder to be filled beyond 80% capacity.
- Read and follow all warnings and instructions that are on the cylinder and that accompany this product.

DANGER

- Never store a spare LP gas cylinder under or near your grill. This could cause excess pressure to be expelled through the vapor relief valve resulting in fire, explosion, or severe personal injury including death.

**Note: PROPANE GAS IS HEAVIER THAN AIR AND WILL COLLECT IN LOW AREAS.
PROPER VENTILATION IS EXTREMELY IMPORTANT.**

- Keep the ventilation opening(s) of the LP gas cylinder enclosure free and clear from obstructions and debris.
- DO NOT insert any foreign objects into the valve outlet. Damage to the back-check could result. A damaged back-check can cause a leak, possibly resulting in explosion, fire, severe bodily harm, or death.

⚠ WARNING

FILLING THE LP GAS CYLINDER:

- Allow only qualified LP gas dealers to properly fill or repair your LP gas cylinder.
- New tanks should be purged prior to filling; inform LP gas dealer if you are using a new tank.
- **DO NOT** allow the cylinder to be filled beyond 80% capacity. Over-filled tanks can create a dangerous condition. Over-filled tanks can build-up pressure and cause the relief valve to expel propane gas vapors. The vapor is combustible and if it comes in contact with a spark source or flame an explosion causing severe burns, bodily harm, or death could occur.
- Always use a protective cylinder cap when grill is not connected to cylinder.
- If you exchange a cylinder with a qualified exchange program, be sure the cylinder has a Type 1 valve and an over-filling prevention device (OPD).

INSTALLING THE LP GAS CYLINDER ONTO THE GRILL:

1. Check that the cylinder valve is closed by turning the knob clockwise.
2. Place the cylinder handle over tank hook and the cylinder base into the tank holder on the bottom of the right shelf legs.
3. Orient the cylinder such that the valve opening faces the front of the grill, and so that the hose is not kinked or damaged.
4. Attach or detach regulator to the LP gas cylinder only when cylinder is at rest in tank holder.

HOSE AND REGULATOR:

Your grill is equipped with a Type 1 connection device with the following features:

1. The system will not allow gas flow from the cylinder until a positive connection to the valve has been made.
Note: The cylinder valve must be turned off before any connection is made or removed.
2. A thermal device that will shut off the gas flow if the device is subject to temperatures above 240°F to 300°F (115°C to 150°C). If this should happen, remove the entire regulator assembly and dispose of properly. A replacement regulator assembly can be purchased by contacting customer service at 800-527-0717. The cause of the excessive heat should be determined and corrected before using your grill again.
3. A regulator flow limiting device, when activated, restricts the flow of gas to 10 cubic feet per hour. If the flow limiting device is activated, perform Regulator Resetting Procedure.

REGULATOR RESETTING PROCEDURE

1. Turn burner control knobs to "OFF", turn off the cylinder valve and disconnect regulator from LP gas tank. Wait approximately two minutes.
2. Reattach regulator and slowly turn cylinder valve back on. The flow limiting device will now be reset.

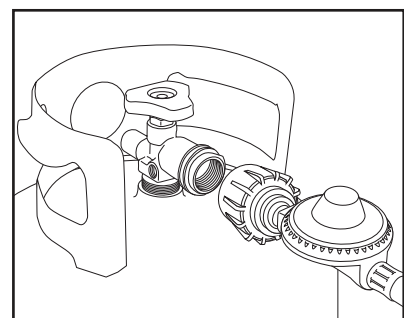
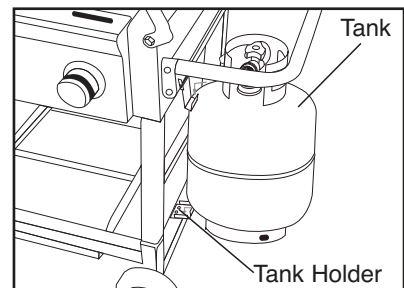
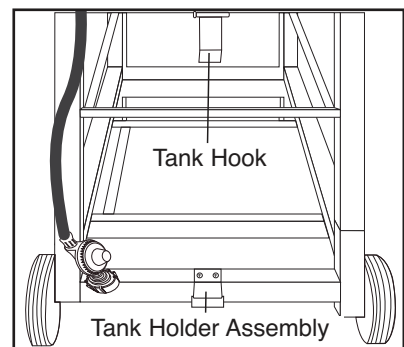

⚠ WARNING

- Never use your grill without leak testing all gas connections and hoses. See the section on "Leak Testing" in this manual for proper procedures.

⚠ WARNING

The pressure regulator and hose assembly supplied with your gas grill must be used.

- DO NOT attempt to connect it to any other fuel supply source such as a natural gas line.
- DO NOT use any other pressure regulator/hose assembly other than the one supplied with your grill. Replacement pressure regulator/hose assembly must be part No 155-9490-0, which can be obtained by contacting customer service at 800-527-0717.
- DO NOT attempt to adjust or repair the regulator. The regulator is designed to operate at a maximum output pressure of 11 inches of water column (2.74 kPa).

During assembly and/or replacement of the gas cylinder, keep the gas supply hose free of kinks and/or damage.

Visually inspect the hose assembly prior to each use for evidence of damage, excess wear, or deterioration. If found, replace the assembly before using your grill. Only the manufacturer's supplied replacement should be used.

⚠ WARNING

CONNECTING HOSE AND REGULATOR TO AN LP GAS CYLINDER

- Ensure the tank valve is **CLOSED** prior to connecting the LP gas cylinder to your grill. Turn the valve knob clockwise to properly close the valve. Read and follow all instructions and warnings on the supply hose safety tags. Read and follow all warnings in this manual concerning the safe use of LP gas cylinders and the hose and regulator before connecting cylinder to grill. Read and follow all warnings on the LP cylinder.

CONNECTING HOSE AND REGULATOR

1. Check that the cylinder valve is closed by turning the knob clockwise.
2. Check that the grill's burner control knobs are in the "OFF" positions.
3. Remove the protective plastic cap from the cylinder valve and the connection device.
4. Hold regulator and insert the nipple of connection device into the LP cylinder valve outlet. Ensure that the device is centered properly.
5. Turn the large coupling nut clockwise by hand and tighten to a full stop. Take care not to cross thread the coupling nut onto the cylinder valve. Do not over-tighten the knob onto the valve. Do not use tools to tighten connection.

Note: If you are unable to make the connection, repeat Steps 4 and 5.

6. Check that the hose does not contain kinks, does not contact sharp edges, and does not contact surfaces that may become hot during use.
7. Leak check all fittings before lighting your grill. See section on "Leak Testing" in this manual.

⚠ DANGER

LEAK TESTING:

To prevent fire or explosion hazard:

- **DO NOT** smoke or permit ignition sources in the area while conducting a leak test.
- Perform test **OUTDOORS** only in a well ventilated area.
- Never perform a leak test with a match or open flame.
- Never perform a leak test while the grill is in use or while grill is still hot.

⚠ WARNING

WHEN TO PERFORM A LEAK TEST:

- After assembling your grill and before lighting for the first time, even if purchased fully assembled.
- Every time the LP gas cylinder is refilled or if any of the gas components are replaced.
- Any time your grill has been moved.
- At least once per year or if your grill has not been used for more than 60 days.

CHECKING FOR LEAKS:

1. Create a mixture of 50% water and 50% liquid dishwashing soap.
2. Open the lid.
3. Ensure all control knobs are set to the "OFF" position.
4. Turn on the fuel supply at the cylinder valve. Turn the cylinder valve knob one turn counter-clockwise.
5. Apply the soap water mixture to the following:

- Ⓐ Supply tank (cylinder) weld.
- Ⓑ Connection nut to tank valve.
- Ⓒ Back side of connection nut to brass nipple.
- Ⓓ Brass nipple connection into regulator.
- Ⓔ Regulator connections to gas supply hoses.
- Ⓕ Hose connection to gas manifold.
- Ⓖ The full length of gas supply hose.
- Ⓗ Tank valve to cylinder.

Watch For Bubbles

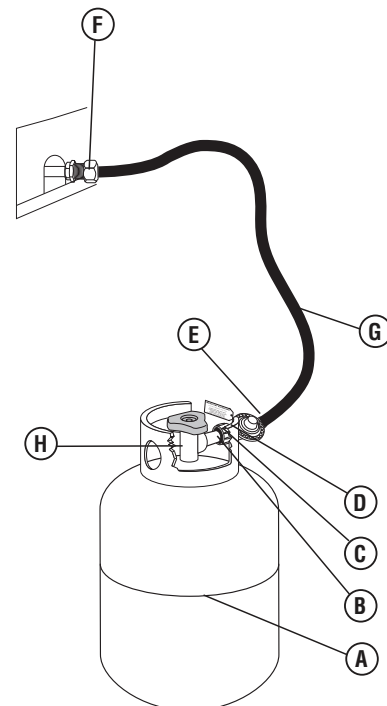
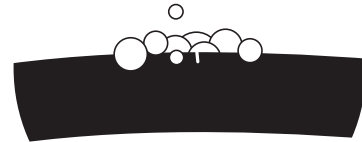

6. Check each place listed (A–H) for growing bubbles which indicates a leak.
7. Turn off gas supply at cylinder valve.
8. Turn on control knobs to release gas pressure in hose.
9. Turn control knobs to "OFF" position.
10. Tighten any leaking connections.
11. Repeat soapy water test until no leaks are detected.
12. Turn off gas supply at cylinder valve until you are ready to use your grill.
13. Wash off soapy residue with cold water and towel dry.
14. Wait 5 minutes to allow all gas to evacuate the area before lighting grill.

⚠ CAUTION! **DO NOT** use the grill if leaks cannot be stopped. Contact a qualified gas appliance repair service.

Note: The leak test must be performed in an area that has adequate lighting in order to see if bubbles are developing.

⚠ WARNING

PRE-START CHECK LIST:

Property damage, bodily harm, severe burns, and death could result from failure to follow these safety steps. These steps should be performed after the grill has been assembled and prior to each use. DO NOT operate this grill until you have read and understand ALL of the warnings and instructions in this manual.

- Ensure that the grill is properly assembled.
- Inspect the gas supply hose for burns, chaffing, kinks, and proper routing before each use. If it is evident there is excessive abrasion or wear, or the hose is cut, it must be replaced prior the grill being used. Replace with hose and regulator, Model No. 155-9490-0, which can be obtained by contacting customer service at 800-527-0717.
- Leak check all gas connections and hose. See section on "Leak Testing".
- Ensure that all electrical supply cords are properly grounded. Keep any electrical supply cord and the fuel supply hose away from any heated surfaces. Hose should be at least 3 inches from hot surfaces.
- Position your grill on level ground in a well ventilated location, a safe distance from combustible materials, buildings and overhangs.
- Properly place the empty grease cup under the grease drain hole in the bottom of the grill to catch grease during use.
- DO NOT obstruct the flow of combustion and ventilation air.

⚠ WARNING

Read, understand and follow all warnings and instructions contained in this manual. **DO NOT** skip any of the warnings and instructions contained in the preceding sections of this manual.

⚠ WARNING

LIGHTING INSTRUCTIONS:

Follow the instructions exactly.

1. **OPEN THE GRILL LID** before attempting to light a burner so that fumes do not accumulate inside the grill. An explosion could occur if grill lid is down.
2. Check that all burner control knobs and the cylinder valve are turned to the "OFF" position.
3. Turn on the fuel supply by rotating the cylinder valve knob counter-clockwise to full open.
4. **DO NOT** stand with head, body, or arms over the grill when lighting.

Note: If burner does not light or flame is too low, you may have spider or other insect blockage in burner, or the flow limiting device has been activated. See "Burner Assembly/Maintenance" under Proper Care and Maintenance, or "Regulator Resetting Procedure" under Connecting LP Cylinder and Hose/Regulator to Grill.

LIGHTING THE MAIN BURNERS:

1. Open lids before lighting burner.
2. Make sure all control knobs are in the "OFF" position.
3. Select the burner to be lit. Push and turn the control knob of that burner to the "HIGH" position.
4. Press the electronic igniter and hold for 3–5 seconds to light burner.
5. If ignition does NOT occur in 5 seconds, turn control knob to "OFF", wait 5 minutes to allow gas to dissipate and repeat lighting procedure.
6. Repeat steps 3–5 for lighting each burner. Always use electronic igniter for lighting each burner. If burner does not ignite using the push-button igniter, wait 5 minutes, see "Match Lighting the Main Burners" section.
7. To turn off, turn each control knob clockwise until it locks in the "OFF" position. This does not turn off the gas flow from the cylinder.

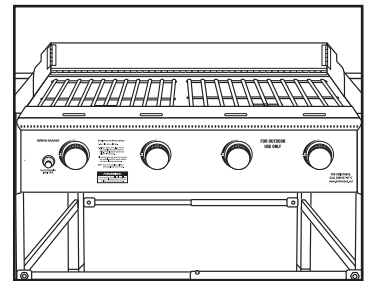

MATCH LIGHTING THE MAIN BURNERS:

1. Open lids before lighting.
2. Turn the burner control knobs to "OFF".
3. Place a paper match in the end of the matchlighter. Strike the match and place through lighting hole in the left hand side of the grill to approximately 1/2" (1 to 2 cm) from the burner.
4. Turn on the **FAR LEFT** burner control knob to the "HIGH" position. The burner should light within 5 seconds.
5. If the burner does not light, turn the control knob to "OFF" and wait 5 minutes for gas to dissipate and repeat lighting procedure.
6. Once lit, light adjacent burners in sequence by pressing in and rotating the control knob to the "HIGH" position.
7. If the burner does not light within the first few attempts of match lighting, there is a problem with the gas supply. Turn off the gas at the burner **and** cylinder. **DO NOT** attempt to operate the grill until the problem is found and corrected. See "Trouble Shooting" section of this manual.

Lighting Hole

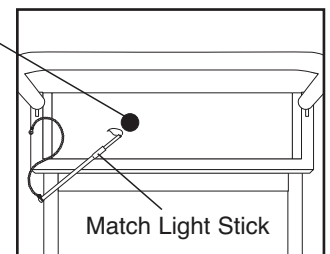

Note: Observe flame height when lit: Flame should be a Blue/Yellow color between 1"-2" when burner is on "HIGH".

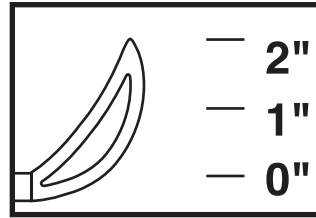

TURNING OFF THE GRILL:

1. Turn off the cylinder valve.
2. Turn all burner control knobs to the "OFF" position.

Note: Turn off LP cylinder first to prevent gas from being left in the system under pressure.

⚠ CAUTION!

- The cylinder valve should always be in the off, or closed, position when the grill is not in use.

To turn off the cylinder valve, turn knob clockwise until it stops.

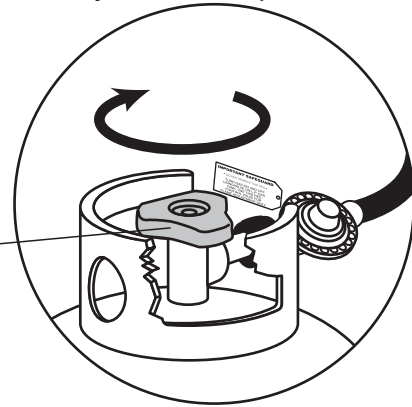

⚠ WARNING

Never operate this grill while grill legs are in the collapsed position, damage to floor or gas hose may occur.

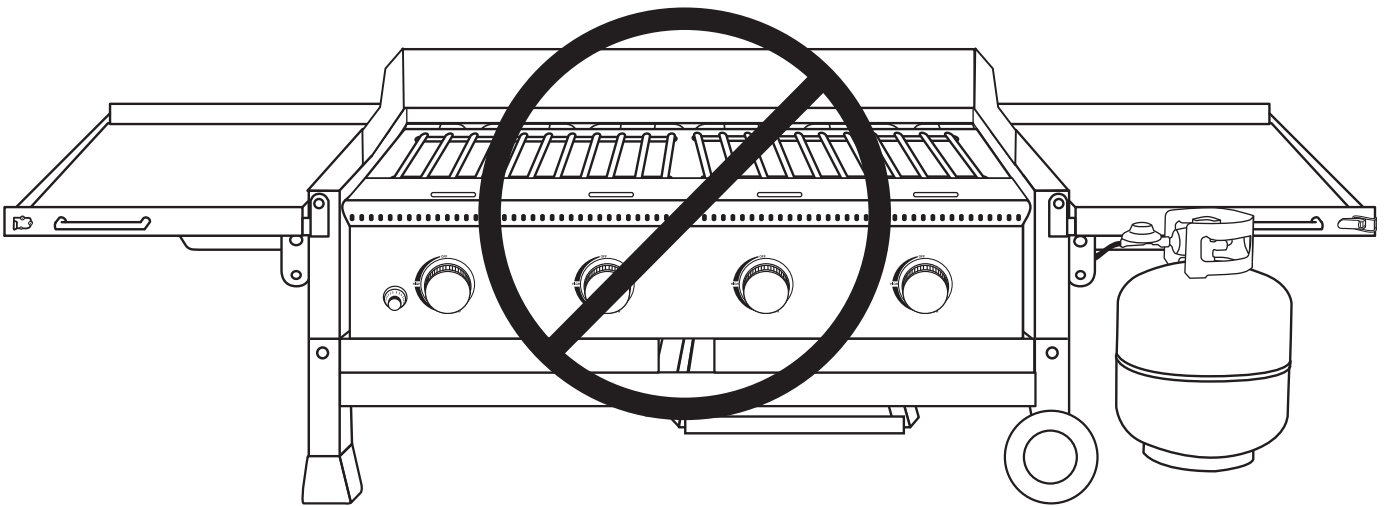

WARNING

OPERATING THE GRILL:

Never use Charcoal or Lighter Fluid inside your Gas Grill. Read and follow all warnings and instructions contained in the preceding sections of this manual.

BREAKING IN YOUR GRILL:

- In manufacturing and preserving the components of your grill, oil residue may be present on the burner and cooking surfaces of your grill.
- Before cooking on your grill for the first time you should preheat it for 15 minutes on "HIGH" to burn off these residual oils.

PREHEATING THE GRILL:

- Prior to use, it is recommended that you preheat your grill. This ensures that the grilling surfaces are at the desired temperatures to sear the food sugars when cooking. After lighting your grill, set the main burner control knobs to the "HIGH" position for 10 to 15 minutes.

CONTROLLING FLARE-UPS:

- Flare-ups are a part of cooking meats on a gas grill. This adds to the unique flavor of cooking on a gas grill. Excessive flare-ups can over-cook your food and cause a dangerous situation for you and your grill. Excessive flare-ups result from the build-up of grease in the bottom of your grill. If this should occur, **DO NOT** pour water onto the flames. This can cause the grease to splatter and could result in serious burns or bodily harm.

WARNING

- **DO NOT** leave your grill unattended while in use.
- **DO NOT** move grill when in use.
- **DO NOT** use water to extinguish flare-ups.
- **Have fire extinguisher readily accessible suitable for use with gas appliances.**

TO MINIMIZE FLARE-UPS:

- Trim excess fat from meats prior to cooking.
- Cook meats with high fat contents (chicken or pork) on Low settings or indirectly.
- Ensure that your grill is on level ground and the grease is allowed to evacuate the grill through the drain hole in the bottom and into grease cup.

INDIRECT COOKING:

- Indirect cooking is the process of cooking your food without the heat source being directly under your food. You can sear meats over a high flame on one side of the grill while slow cooking a roast on the other (unlit) side of the grill.

GRILL COOKING TIPS

CLEANLINESS

- Always wash hands thoroughly with soap and hot water prior to handling food and after handling raw meat, uncooked poultry or seafood.
- When using a platter to carry raw meat, uncooked poultry or seafood to the grill, make sure to wash the platter thoroughly with soap and hot water before placing cooked foods back on the platter or use different platters for raw and cooked foods.
- Never use the same utensils when handling raw meat, uncooked poultry or seafood unless you wash the utensils thoroughly with soap and hot water.
- Never re-use marinade from raw meat or uncooked poultry on foods that have been cooked and are ready to be served.

GRILLING TO PROPER TEMPERATURE

- Use a meat thermometer to be sure food has reached a safe internal temperature.
- The US Department of Agriculture recommends the **minimum** temperature be reached for the following food items:

Chops	145 degrees F (62.8° C)
Ground Meat	160 degrees F (71° C)
Pork	160 degrees F (71° C)
Poultry	180 degrees F (82° C)
Roasts	145 degrees F (62.8° C)
Seafood	140 degrees F (60° C)
Vegetables	145 degrees F (62.8° C)

HELPFUL HINTS

- If you pre-cook meat or poultry, do so immediately before grilling.
- Never defrost meat at room temperature or on a countertop.
- Refrigerate leftovers within 2 hours of taking food off the grill.
- For additional information, please phone the USDA's toll free Meat & Poultry Hotline at 800-535-4555.

PROPER CARE & MAINTENANCE

- To protect your grill from excessive rust, the unit must be kept clean and covered at all times when not in use.
- Wash cooking grills and heat distribution plates with hot, soapy water, rinse well and dry. Lightly coat cooking grill with vegetable oil or vegetable oil spray.
- Clean inside and outside of grill by wiping off with a damp cloth. Apply a light coat of vegetable oil or vegetable oil spray to the interior surface to prevent rusting.
- The stainless steel exterior surface of your grill, can be cleaned with stainless steel cleaner.
- Never apply paint to the interior surface. Rust spots on the interior surface can be buffed, cleaned, then lightly coated with vegetable oil or vegetable oil spray to minimize rusting.

CLEANING AND MAINTENANCE:

- Keep the appliance free and clear of combustible materials, gasoline and other flammable vapors and liquids.
- Keep the ventilation openings of the cylinder enclosure free and clear of debris.
- Visually check burner flames for proper operation (see pictorial in "Burner Assembly/Maintenance" under Proper Care and Maintenance). Spiders or other insects can nest in the burner causing gas blockage.
- For safe grilling and peak performance of your grill, perform these checks at least twice per year or after extended periods of storage.
- Be sure to tighten up all hardware (nuts, bolts, screws, etc.) at least twice per year.

⚠ CAUTION! Some parts may contain sharp edges. Wear protective gloves if necessary.

- Remove the cooking grills, heat distribution plates, and burners from inside your grill. Use a brush with hot water and detergent to remove excess residue. NEVER use a commercial oven cleaner. Rinse completely with water. Towel dry and replace all components as described in the assembly instructions.

BURNER ASSEMBLY/MAINTENANCE

- Although your burners are constructed of stainless steel, they may corrode as a result of the extreme heat and acids from cooking foods. Regularly inspect the burners for cracks, abnormal holes, and other signs of corrosion damage. If found, replace the burner.
- **DO NOT obstruct the flow of combustion and ventilation air.** Burner tubes can become blocked by spiders and other insects building their nests. Blocked burner tubes can prevent gas flow to the burners and could result in a burner tube fire or fire beneath the grill. To clean the Burner Assembly follow these instructions to clean and/or replace parts of burner assembly or if you have trouble igniting the grill.

1. Turn gas off at control knobs and LP cylinder tank valve.
2. Remove cooking grills and heat distribution plates.
3. Remove screw from each burner "foot" using a screwdriver.
4. Carefully lift each burner up and away from valve openings.
5. Use a narrow bottle brush or a stiff wire bent into a small hook to run through each burner tube and flame port several times.

Note: Wear eye protection when performing procedure 6.

6. Use compressed air to blow into burner tube and out the flame ports. Check each port to make sure air comes out each hole.
7. Wire brush entire outer surface of burner to remove food residue and dirt.
8. Check burner for damage, if any large cracks or holes are found replace burner.

IMPORTANT: Burner opening must slide over valve nozzle.

9. Carefully align crossover channels between burners and orient burners CORRECTLY by aligning screw hole in burner to the left as shown. The burner should be equal distant between the crossover channels.
10. Replace screw on each burner and follow the "Gas Leak Testing" section of this manual. Relight burners to verify proper operation.
11. Replace heat distribution plates and cooking grills.

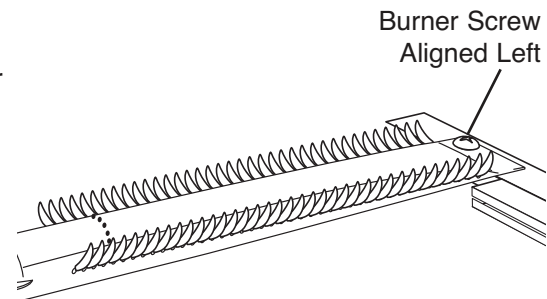
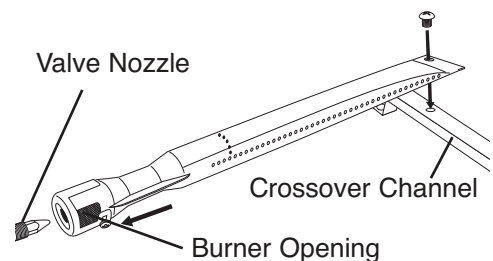
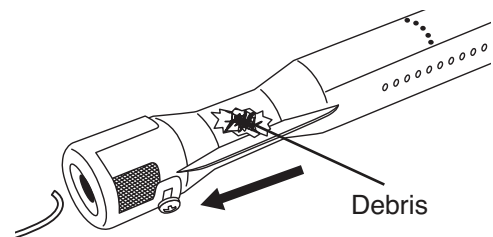

PROPER BURNER OPERATION

COOKING GRILLS

- Clean with mild soap detergent and water. A brass bristled brush or a nylon cleaning pad can be used to remove residue from the stainless steel surfaces. Do not use steel wire bristles to clean the cooking grills. Steel can cause the finish to chip or crack. DO NOT use a commercial oven cleaner.

HEAT DISTRIBUTION PLATES

- Periodically, it may be necessary to inspect and clean the heat distribution plate to prevent excess grease build-up. When the grill is cold, remove the cooking grills. Inspect the heat distribution plates and replace if broken or damaged. Do not allow heat distribution plates to become damaged to the extent that they may fall through onto the burners. Replace the heat distribution plates and cooking grills and light the burners. Operate the grill on "HIGH" for 10 minutes to remove the excess grease.

WARNING

TRANSPORTING AND STORAGE:

- **Never move a grill when it is hot or when objects are on the cooking surfaces.**
- **Make sure that cylinder valve is shut off. After moving the grill check that all gas connections are free of leaks. Refer to instructions for Leak Testing.**
- **DO NOT store a spare LP gas cylinder (filled or empty) under or near the grill.**
- **Never store flammable liquids or spray canisters under or near the grill.**
- **DO NOT extinguish grease fires using water.**
- **If the outdoor cooking gas appliance is not in use, the gas must be turned off at the supply cylinder.**
- **Storage of an outdoor cooking gas appliance indoors is permissible only if the cylinder is disconnected and removed from the outdoor cooking gas appliance.**
- **Cylinders must be stored outdoors out of reach of children and must not be stored in a building, garage or any other enclosed area.**
- **When removing the grill from storage, spider webs or other debris may be blocking the burner. See "Burner Assembly/Maintenance" under Proper Care and Maintenance.**

BEFORE STORING YOUR GRILL:

- Ensure that the cylinder valve is fully closed.
- Clean all surfaces.
- Lightly coat the burners with cooking oil to prevent excess rusting.
- If storing the grill indoors, disconnect the LP tank and leave the LP tank OUTDOORS.
- Place a protective cap cover on the LP tank and store the tank outdoors in a well ventilated area out of direct sunlight.
- Clean burner prior to use after storing, at the beginning of grilling season or after a period of one month not being used. Spiders and insects like to build nests in burner tubes (especially during colder months). These nests can cause fires in burner tubes or under grill.
- If storing the grill outdoors, cover the grill with a grill cover for protection from the weather.

TROUBLE SHOOTING

Problem:	Possible Causes:
<ul style="list-style-type: none"> • Burner will not light 	<ol style="list-style-type: none"> 1. Check LP cylinder fuel level. 2. Bad electrode spark. Check to see if the grill will match light. Electrode or collector may need adjustment. 3. Burner may not be properly seated. 4. Burner may be obstructed. 5. The cylinder valve may be closed. 6. Regulator is not properly seated on cylinder valve.
<ul style="list-style-type: none"> • Fire at control knob 	<ol style="list-style-type: none"> 1. Burner holes may be obstructed. See section on "Burner Assembly/Maintenance" under Proper Care and Maintenance. 2. Burner is improperly seated on control valve. 3. Gas connections may be loose. Leak Check and tighten all connections.
<ul style="list-style-type: none"> • Yellow Flames at burner 	<ol style="list-style-type: none"> 1. Burner is obstructed. See section on "Burner Assembly/Maintenance" under Proper Care and Maintenance.
<ul style="list-style-type: none"> • Flame blows out on "LOW" 	<ol style="list-style-type: none"> 1. Burner holes may be obstructed. See section on "Burner Assembly/Maintenance" under Proper Care and Maintenance. 2. Grill is not sufficiently preheated. 3. Burner is improperly seated on control valve.
<ul style="list-style-type: none"> • Burner does not get hot enough 	<ol style="list-style-type: none"> 1. Flow control device has been activated in regulator. See Regulator Resetting Procedure under Connecting LP Cylinder and Hose/Regulator to Grill.
<ul style="list-style-type: none"> • Grill is Too Hot 	<ol style="list-style-type: none"> 1. Excess grease build-up causing grease fires. 2. Damaged or faulty regulator. Replace with factory authorized parts. 3. Cook on a lower temperature setting.

FREQUENTLY ASKED QUESTIONS

Your grill's serial number and model number, and the contact information for Brinkmann Customer Service, are listed on a silver label found beneath the control panel, on the back of the grill or on the side of the grill body, under the side shelf.

These questions and answers are for your general knowledge, and may not be applicable to your model grill.

Question: Why does my grill not light properly?

Answer: Always follow lighting instructions as listed on the control panel or in this manual. Also check these causes:

- Check LP gas supply.
- Check to ensure all gas connections are secure.
- The igniter AA battery may need replacing.
- Ignition wires may be loose. Remove the battery, inspect the igniter junction box found behind the control panel and connect any loose wires.
- Spark electrode tips may need repositioning. With the gas supply closed and control knob set to the "OFF" position, press the igniter button and have another person watch for the presence of a spark at the electrode tips. The gap between the spark electrode tip and spark receiver should be about 3/16". If the electrode tip needs to be adjusted, bend it to the appropriate gap distance.
- Check that the end of each burner venturi tube is properly located over its gas valve orifice fitting.
- There may be an obstruction in the gas line. To correct this, remove LP gas hose / regulator or natural gas fuel line from your grill. Open gas supply for one second to test for obstruction. If no obstruction is present, reconnect fuel line. If the fuel line is blocked, replace with a new hose / regulator assembly.
- If an obstruction is suspected in the hose / regulator assembly, orifice or gas valves call Brinkmann Customer Service at 800-527-0717.

Question: Why does my LP gas grill have a low flame or a flame with orange / yellow color?

Answer: You need to purge air from the gas line or reset the regulator's flow limiting device. Opening the cylinder valve all the way or too quickly triggers the regulator's flow limiting device to shut down the gas flow, which prevents excessive gas flow to your grill. NOTE: This procedure should be done every time a new LP gas tank is connected to your grill:

RESETTING THE REGULATOR FLOW LIMITING DEVICE

- Turn control knob to the "OFF" position.
- Turn off the LP gas tank at the cylinder valve.
- Disconnect regulator from LP gas tank.
- Let tank stand for two minutes.
- Reconnect regulator to the LP gas tank.
- Open grill lid or side burner lid. Turn the cylinder valve on slowly until 1/4 or 1/2 open.
- Light the grill by following the instructions on your control panel or in this owner's manual.

Question: How and when do I clean the interior cooking components of my grill?

Answer: Use a fiber or brass cleaning brush to clean the interior of the grill, cooking grills, heat distribution plates and grease containers. Never use a wire brush or metal scraper on porcelain-finished parts, as they can scratch or chip the porcelain finish and promote rusting.